

# Data Logger CL23



- 1 Channel Analog Input (4 - 20 mA, 0 - 10 VDC)
- 2 Channels Totalizer
- Memory 64 Kbyte (Up to 256 Kbyte)
- Data exportable to MS Excel

**Data Logger CL23** is an instrument for recording values of three signal channels: one analog signal and two digital signals (as counters). It's very small size makes it highly portable and with battery installed inside.

The Data Logger has its own software, which must be used in order to set its configuration, to record, to transfer data from CL23 to keep in a computer and to show data in the forms of tables and graphs. Moreover, the user can use this software to change file to CSV file which can be opened by Microsoft Excel.

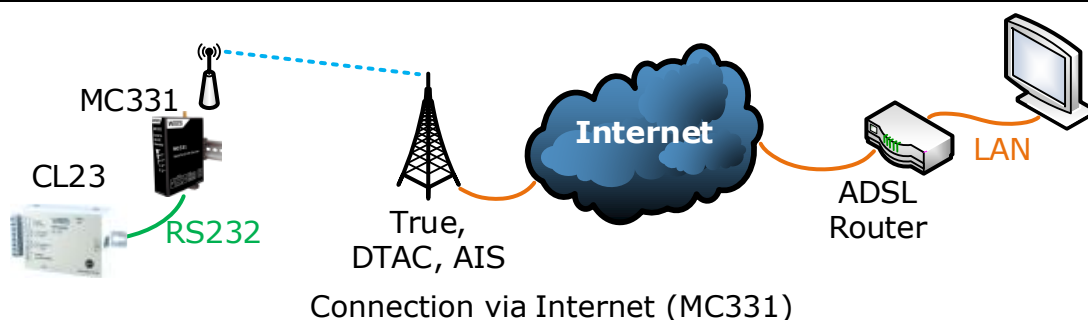
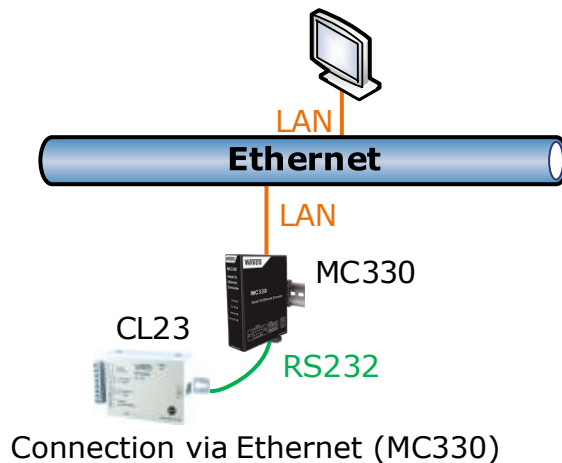

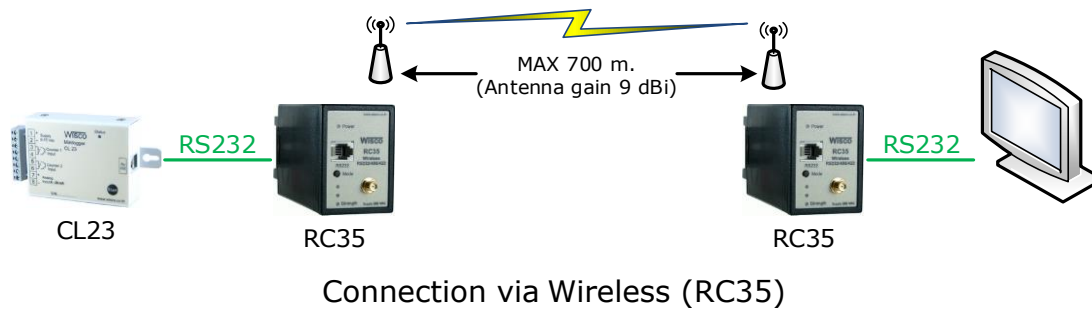

## Specification

### Serial Interface

**Serial Standard:** RS-232 Connector RJ12

**Distance:** RS-232 Length 15 m.

### Serial Parameter

**Baud Rate:** 19200

**Data Bits:** 8

**Stop Bits:** 1

**Parity:** None

### Analog Input

**Number of Channel:** 1 Channel

**Input Type:** Current, Voltage

**Input Range:**

Current (4 to 20 mA)

Voltage (0 to 5, 1 to 5, 0 to 10 VDC Optional)

**ADC Resolution:** 10 Bits

**Accuracy:**  $\pm 0.2$  % of span

### Totalizer Input

**Number of Channel:** 2 Channels

**Sensor Type:** NPN open-collector or dry contact

**I/O Mode:** Even Counter

**Dry Contact:**

ON : Short to GND

OFF : Open

**Counter Frequency:** 20 Hz

**Minimum Pulse Width:** 50 msec

**Ordering Information:** Specify Memory, Analog Input

Example CL23/64Kbytes/4-20mA

### Package Checklist

1. CL23
2. RS-232 Cable

### Recording

**Storage Internal:** 64 Kbyte (256 Kbyte Optional)

**Recording Interval:** 1 sec - 18 Hours (Programmable)

**Record Mode:** Stop when full and Roll over

**Recording by:** Button SW, DI Trig

**Data Format:** Can be exported to MS Excel

**Data Capacity:** 10,880 Records that 64 Kbytes (3 Channels)

### Power Requirements

**Power Supply:** Battery 6.2 VDC @ 1 AH (Sanyo CR123A Lithium)

### Power Consumption

**Standby:** 30  $\mu$ A @ 6 VDC

**Start Record:** 500  $\mu$ A @ 6 VDC

### Environmental Limits

**Operating Temperature:** 0 to 55 °C

**Operating Humidity:** 5 to 95% RH

**Storage Temperature:** 0 to 70 °C

### Physical Characteristics

**Dimension:** W81 x H61 x D26 mm.

### Warranty

**Warranty Period:** 1 Year

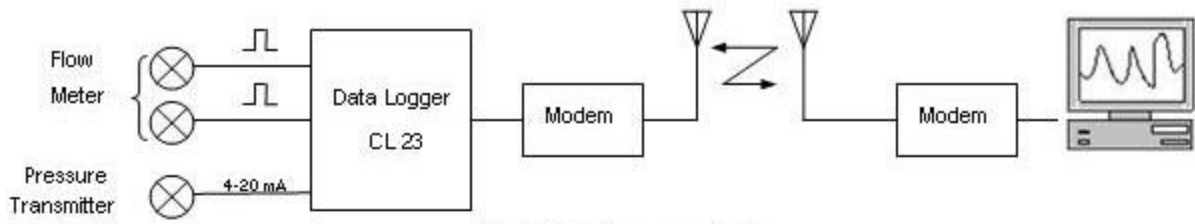

ตัวอย่างใช้เก็บข้อมูลระบบประปา

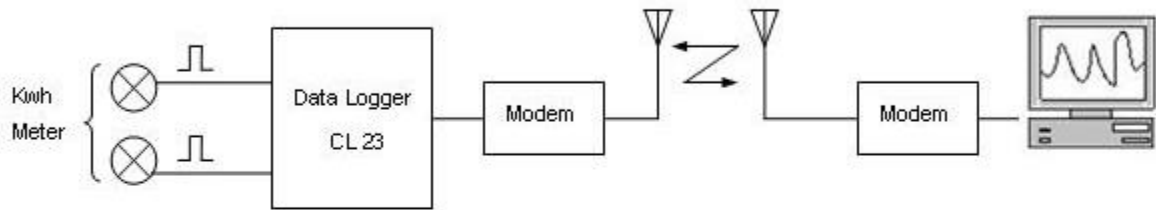

เก็บข้อมูลปริมาณการใช้ไฟฟ้า

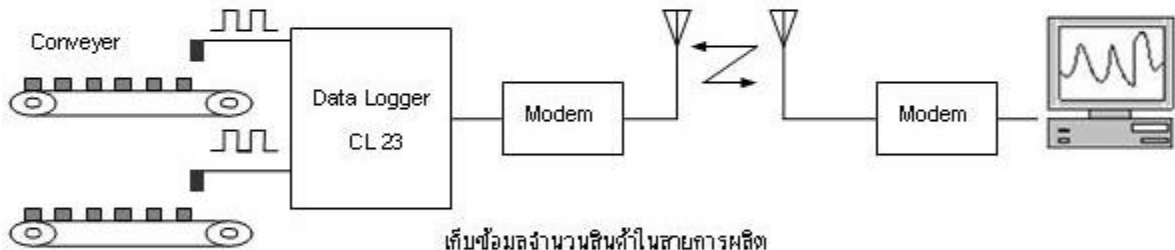

เก็บข้อมูลจำนวนสินค้าในสายการผลิต

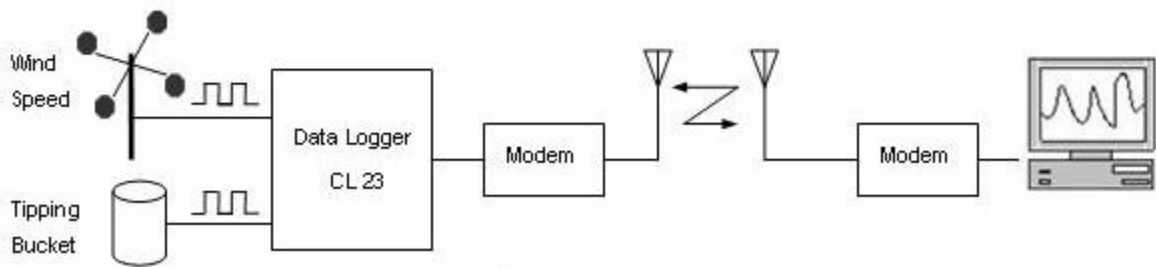

เก็บข้อมูลปริมาณน้ำฝนและความเร็วลมในงานอุตุนิยมวิทยา